



UNMATCHED PERFORMANCE & VISIBILITY

Introducing the Ignite Laser LED Driving Lights and Lightbars - the ultimate lighting solution for work and adventure.

Ignite has revolutionised the LED driving light and lightbar landscape with their innovative Laser LED technology. These lights deliver exceptional lighting performance, offering both distance and unmatched light output.



9" Laser LED Driving Light



Part Number: IDL2306S
Interchangeable
orange / black bezel included



Size	9"	12V Current Draw	11.4A
Width	225mm	24V Current Draw	5.7A
Wattage	152 Watt	Colour	6,000K
Light Source - High Intensity LP LED's	22 x 6 Watt	Operating Temperature	-40°C ~ +60°C
Light Source - OSRAM Laser LED's	1 x 20 Watt	ECE Rating	ECE R10 and CE
Light Output - Raw	14,500 Lumens	IP Rating	IP68 and IP69K
Light Output - Effective	12,300 Lumens	Lifespan	50,000 Hours
1 Lux Rating	1,008m	Warranty	5 Year
Peak Beam Intensity	1,016,000cd	Weight	2.6kg
Voltage	9 - 36 Volt		

Unmatched performance, unparalleled visibility

The combination of Laser LED and LED Illumination technology provides superior lighting output, increasing the normal laser 2° spot beam pattern to an impressive 8°, ensuring optimal visibility on the road.

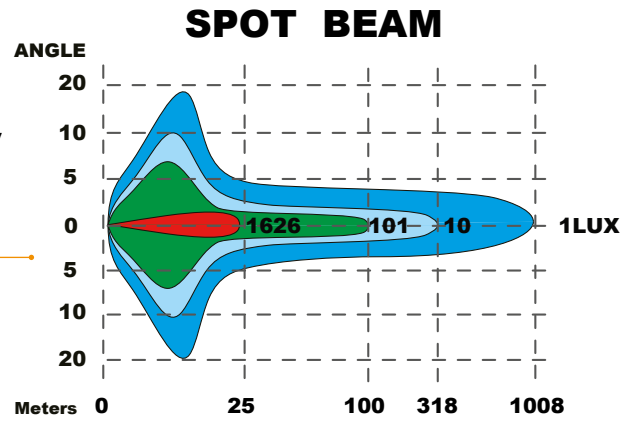

Illuminate your path with power and clarity

Illuminate your path with power and clarity as the 22 x 6 Watt high-intensity LP LED's and 1x 20W OSRAM Laser LED produce an impressive 14,500 Raw Lumens and 12,300 Effective Lumens.



Laser LED close up

Built to conquer every adventure

With UV, water, and shock resistance up to 15G, along with anti-rust, corrosion, and freezing resistance, this light is ready to tackle any adventure that comes your way.

Engineered to be reliable

The Ignite 9" Driving Lights comply with ECE R10 and CE international standards and offer IP68 and IP69K rating for dust and water ingress protection, as well as high pressure washing.

With over and under voltage protection and reverse polarity protection, these lights guarantee long-lasting performance with a lifespan of 50,000 hours.

Easy installation

Installation is a breeze with the stainless-steel multiple bolt mount bracket and included hardware.

Backed by a 5 year warranty

Illuminate your journey with confidence, knowing Ignite has your back.

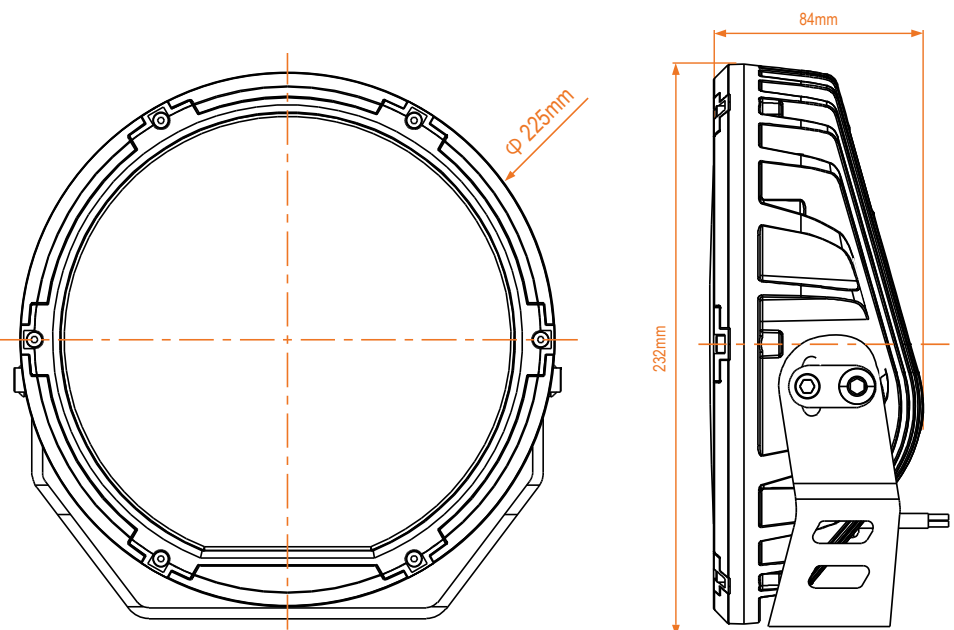

Dual Row Laser LED Lightbars



Combining laser and LED technology, Ignite Dual Row Laser LED Lightbars delivers a powerful 20° combo beam pattern for exceptional lighting performance.

With high-intensity LP LED's and OSRAM Laser LEDs, ensuring the brightest possible light output for any terrain.

Built tough for extreme conditions with over and under voltage protection, and UV, water, and shock resistance.

With a 50,000-hour LED lifespan and a 5-year warranty, the Ignite Lightbar guarantees long-lasting performance.

Ignite LED Driving Light



Headlights On Only

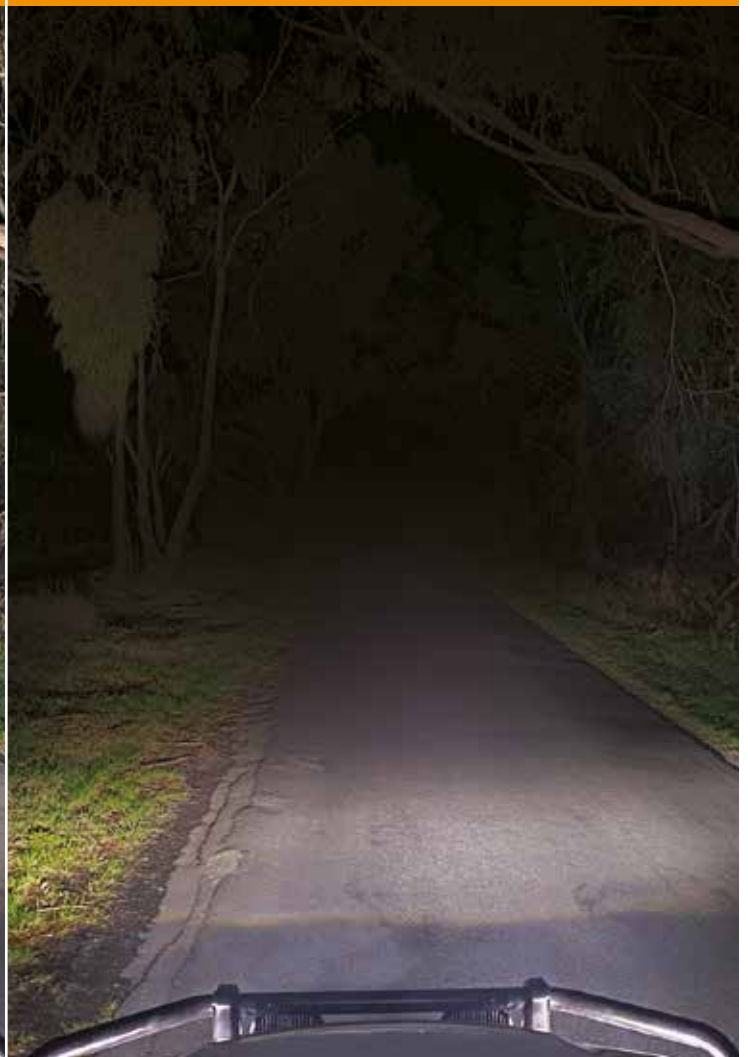

10" Laser LED Lightbar

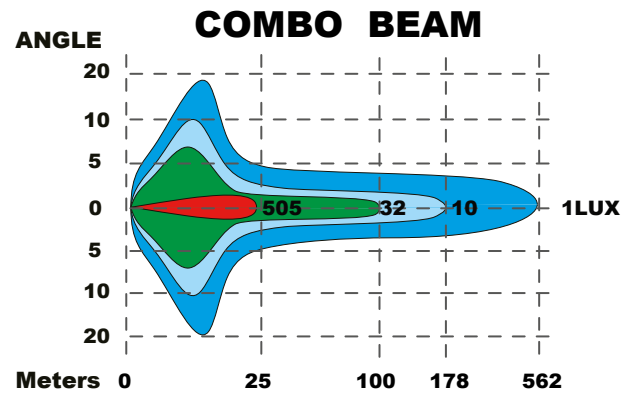
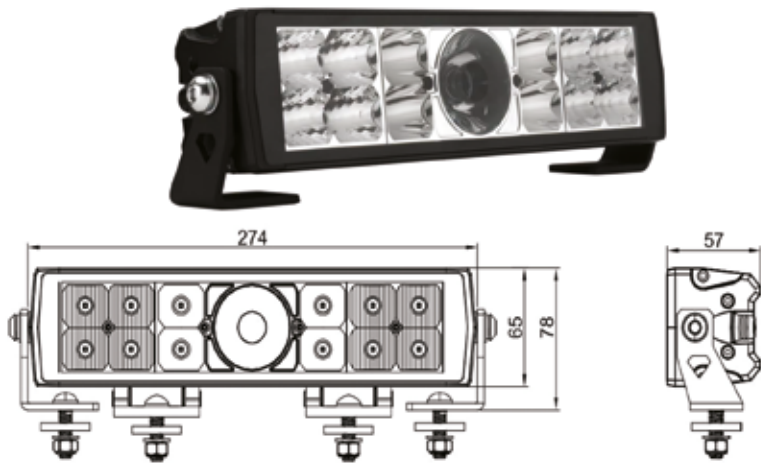

Part Number: ILLB1204

Size	10"	12V Current Draw	4.9A
Length	274mm	24V Current Draw	2.5A
Wattage	68 Watt	Colour	6,000K
Light Source - High Intensity LP LED's	12 x 4 Watt	Operating Temperature	-40°C ~ +60°C
Light Source - OSRAM Laser LED's	1 x 20 Watt	ECE Rating	ECE R112, R10 & CE
Light Output - Raw	6,400 Lumens	IP Rating	IP68 and IP69K
Light Output - Effective	5,400 Lumens	Lifespan	50,000 Hours
1 Lux Rating	562m	Warranty	5 Year
Peak Beam Intensity	317,000cd	Weight	1.3kg
Voltage	9 - 36 Volt		

15" Laser LED Lightbar

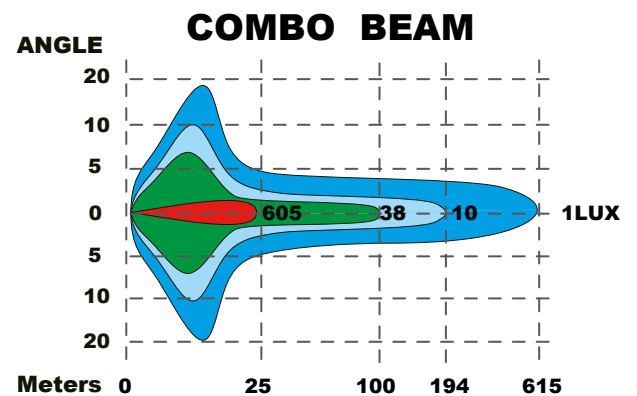
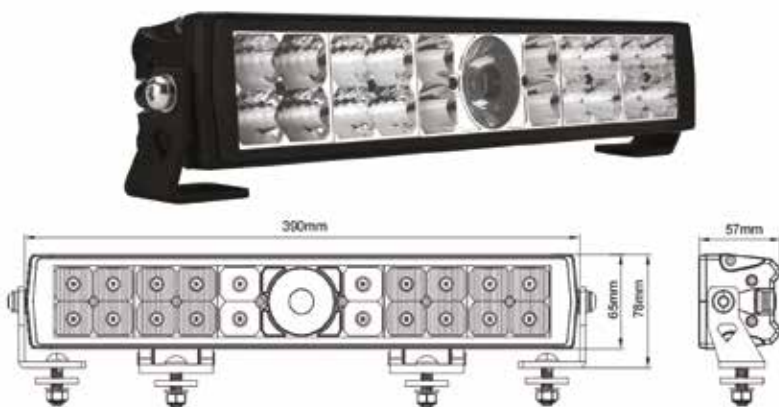

Part Number: ILLB2004

Size	15"	12V Current Draw	6.5A
Length	390mm	24V Current Draw	3.3A
Wattage	95 Watt	Colour	6,000K
Light Source - High Intensity LP LED's	20 x 4 Watt	Operating Temperature	-40°C ~ +60°C
Light Source - OSRAM Laser LED's	1 x 20 Watt	ECE Rating	ECE R112, R10 & CE
Light Output - Raw	8,700 Lumens	IP Rating	IP68 and IP69K
Light Output - Effective	7,400 Lumens	Lifespan	50,000 Hours
1 Lux Rating	615m	Warranty	5 Year
Peak Beam Intensity	378,000cd	Weight	1.7kg
Voltage	9 - 36 Volt		

20" Laser LED Lightbar

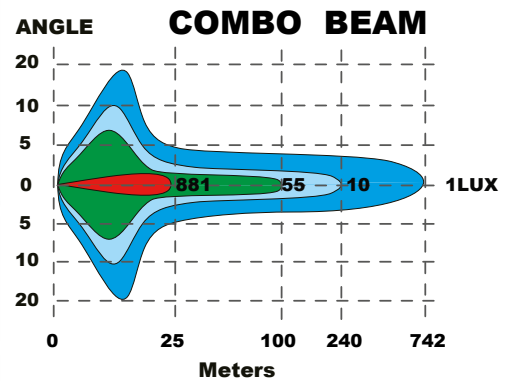
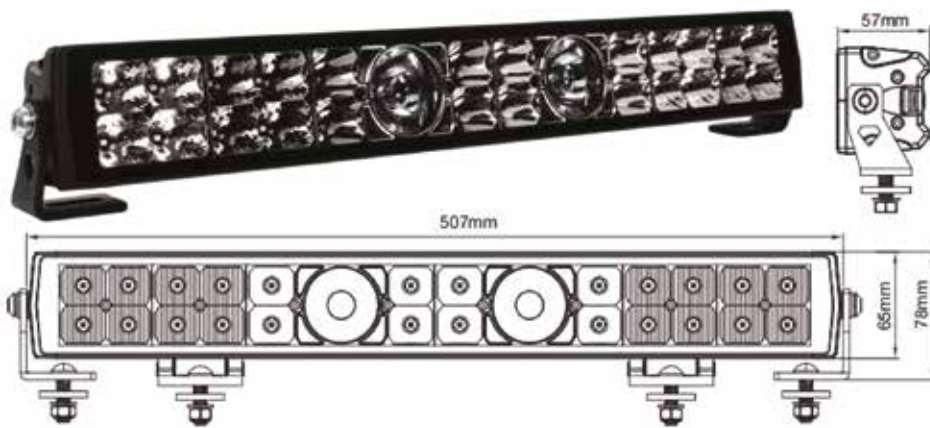

Part Number: ILLB2404

Size	20"	12V Current Draw	9.8A
Length	507mm	24V Current Draw	4.8A
Wattage	136 Watt	Colour	6,000K
Light Source - High Intensity LP LED's	24 x 4 Watt	Operating Temperature	-40°C ~ +60°C
Light Source - OSRAM Laser LED's	2 x 20 Watt	ECE Rating	ECE R112, R10 & CE
Light Output - Raw	11,500 Lumens	IP Rating	IP68 and IP69K
Light Output - Effective	9,800 Lumens	Lifespan	50,000 Hours
1 Lux Rating	742m	Warranty	5 Year
Peak Beam Intensity	551,000 cd	Weight	2kg
Voltage	9 - 36 Volt		

30" Laser LED Lightbar

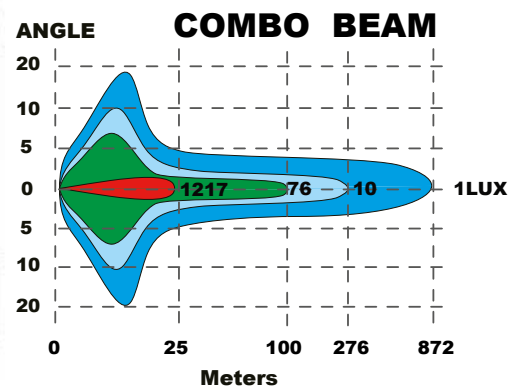
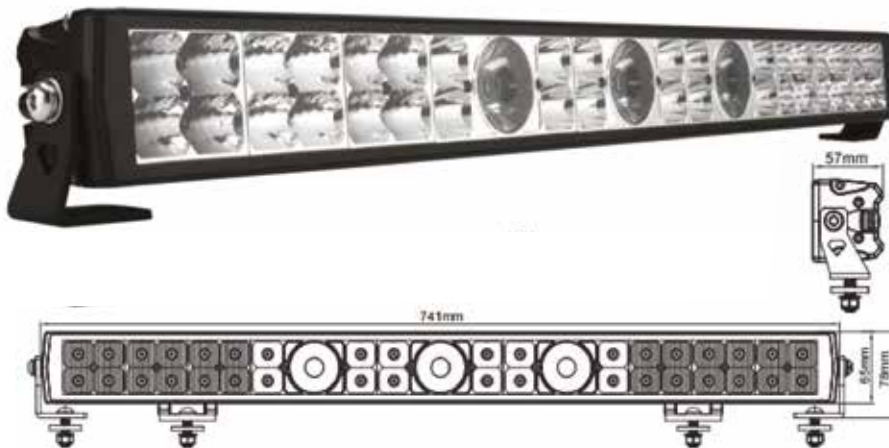

Part Number: ILLB3604

Size	30"	12V Current Draw	13.5A
Length	741mm	24V Current Draw	6.2A
Wattage	204 Watt	Colour	6,000K
Light Source - High Intensity LP LED's	36 x 4 Watt	Operating Temperature	-40°C ~ +60°C
Light Source - OSRAM Laser LED's	3 x 20 Watt	ECE Rating	ECE R10 & CE
Light Output - Raw	17,000 Lumens	IP Rating	IP68 and IP69K
Light Output - Effective	14,400 Lumens	Lifespan	50,000 Hours
1 Lux Rating	872m	Warranty	5 Year
Peak Beam Intensity	761,000cd	Weight	2.9kg
Voltage	9 - 36 Volt		

40" Laser LED Lightbar

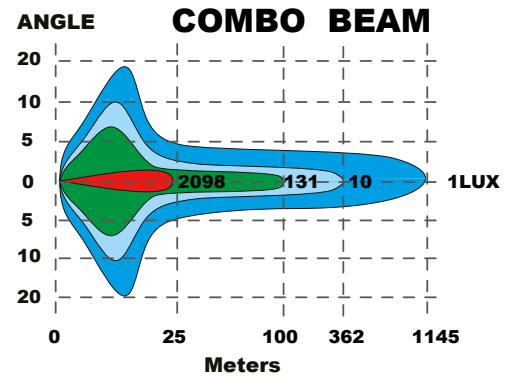
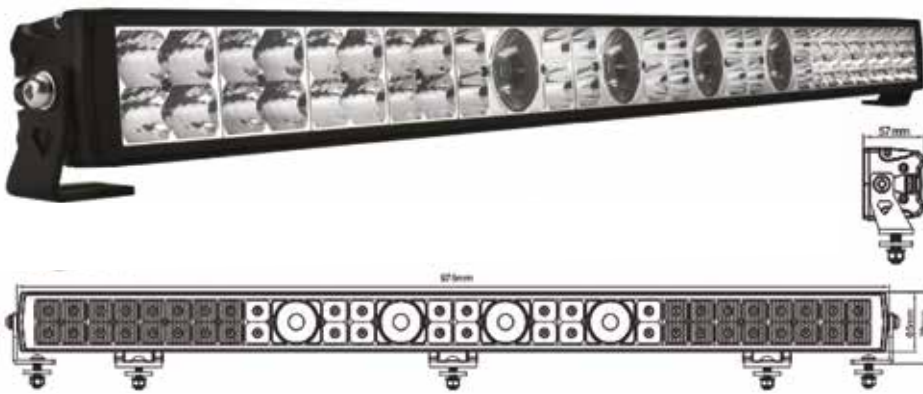

Part Number: ILLB4804

Size	40"
Length	975mm
Wattage	272 Watt
Light Source - High Intensity LP LED's	48 x 4 Watt
Light Source - OSRAM Laser LED's	4 x 20 Watt
Light Output - Raw	20,000 Lumens
Light Output - Effective	1,700 Lumens
1 Lux Rating	1,145m
Peak Beam Intensity	1,312,000cd
Voltage	9 - 36 Volt

12V Current Draw	15.2A
24V Current Draw	7.5A
Colour	6,000K
Operating Temperature	-40°C ~ +60°C
ECE Rating	ECE R10 & CE
IP Rating	IP68 and IP69K
Lifespan	50,000 Hours
Warranty	5 Year
Weight	3.6kg

50" Laser LED Lightbar

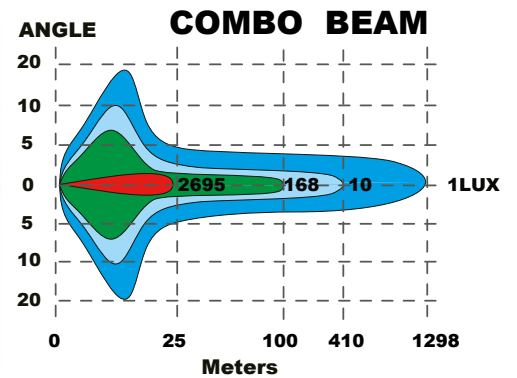

Part Number: ILLB6804

Size	50"
Length	1326mm
Wattage	372 Watt
Light Source - High Intensity LP LED's	68 x 4 Watt
Light Source - OSRAM Laser LED's	5 x 20 Watt
Light Output - Raw	28,000 Lumens
Light Output - Effective	23,800 Lumens
1 Lux Rating	1,298m
Peak Beam Intensity	1,683,000cd
Voltage	9 - 36 Volt

12V Current Draw	23.5A
24V Current Draw	10.1A
Colour	6,000K
Operating Temperature	-40°C ~ +60°C
ECE Rating	ECE R10 & CE
IP Rating	IP68 and IP69K
Lifespan	50,000 Hours
Warranty	5 Year
Weight	5kg

Comparison Chart

SPECIFICATIONS	10" LIGHTBAR	15" LIGHTBAR	20" LIGHTBAR	30" LIGHTBAR	40" LIGHTBAR	50" LIGHTBAR
Length	274mm	390mm	507mm	741mm	975mm	1,326mm
Wattage	68 Watt	95 Watt	136 Watt	204 Watt	272 Watt	372 Watt
Light Source - High Intensity LP LED's	12 x 4 Watt	20 x 4 Watt	24 x 4 Watt	36 x 4 Watt	48 x 4 Watt	68 x 4 Watt
Light Source - OSRAM Laser LED's	1 x 20 Watt	1 x 20 Watt	2 x 20 Watt	3 x 20 Watt	4 x 20 Watt	5 x 20 Watt
Light Output - Raw	6,400 Lumens	8,700 Lumens	11,500 Lumens	17,000 Lumens	20,000 Lumens	28,000 Lumens
Light Output - Effective	5,400 Lumens	7,400 Lumens	9,800 Lumens	14,400 Lumens	1,700 Lumens	23,800 Lumens
1 Lux Rating	562m	615m	742m	872m	1,145m	1,298m
Peak Beam Intensity	317,000cd	378,000cd	551,000 cd	761,000cd	1,312,000cd	1,683,000cd
Voltage	9 - 36 Volt	9 - 36 Volt	9 - 36 Volt	9 - 36 Volt	9 - 36 Volt	9 - 36 Volt
12V Current Draw	4.9A	6.5A	9.8A	13.5A	15.2A	23.5A
24V Current Draw	2.5A	3.3A	4.8A	6.2A	7.5A	10.1A
Colour	6,000K	6,000K	6,000K	6,000K	6,000K	6,000K
Operating Temperature	-40°C ~ +60°C	-40°C ~ +60°C	-40°C ~ +60°C	-40°C ~ +60°C	-40°C ~ +60°C	-40°C ~ +60°C
ECE Rating	ECE R112, R10 & CE	ECE R112, R10 & CE	ECE R112, R10 & CE	ECE R10 & CE	ECE R10 & CE	ECE R10 & CE
IP Rating	IP68 and IP69K	IP68 and IP69K	IP68 and IP69K	IP68 and IP69K	IP68 and IP69K	IP68 and IP69K
Lifespan	50,000 Hours	50,000 Hours	50,000 Hours	50,000 Hours	50,000 Hours	50,000 Hours
Warranty	5 Year	5 Year	5 Year	5 Year	5 Year	5 Year
Weight	1.3kg	1.7kg	2kg	2.9kg	3.6kg	5kg
Part Number	ILLB1204	ILLB2004	ILLB2404	ILLB3604	ILLB4804	ILLB6804

